

**PROGRAM PASCASARJANA MAGISTER MANAJEMEN  
UNIVERSITAS BUDI LUHUR**

# **SISTEM INFORMASI MANAJEMEN**

Oleh :  
**Deni Mahdiana, S.Kom, MM, M.Kom**



# **INFORMATION SYSTEM DEVELOPMENT**

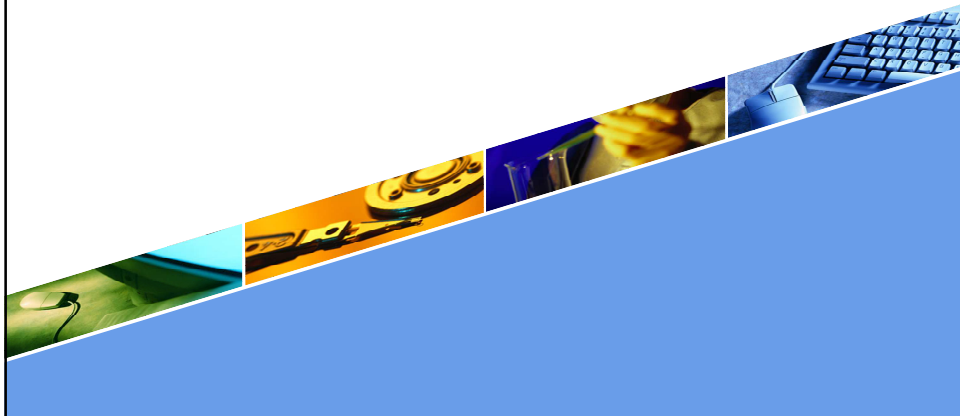

## What is the System Development Cycle?

- What is an **information system (IS)**?

Hardware, software, data, people, and procedures that work together to produce quality information

**System**—Set of components that interact to achieve common goal

Businesses use many types of systems

p. 620

Next

## The System Development Life Cycle

- What are the phases of the **system development cycle**?

### Phase 1. Planning

- Review project requests
- Prioritize project requests
- Allocate resources
- Form project development team

### Phase 2. Analysis

- Conduct preliminary investigation
- Perform detailed analysis activities:
  - Study current system
  - Determine user requirements
  - Recommend solution

### Phase 3. Design

- Acquire hardware and software, if necessary
- Develop details of system

### Phase 4. Implementation

- Develop programs, if necessary
- Install and test new system
- Train users
- Convert to new system

### Phase 5. Operating, Support, and Security

- Perform maintenance activities
- Monitor system performance
- Assess system security

Next

## What is the System Development Cycle?

- What are guidelines for system development?

Arrange tasks into phases  
(groups of activities)

Involve **users** (anyone for whom  
system is being built)

Develop clearly defined **standards** (procedures  
company expects employees to follow)

Next

## What is the System Development Cycle?

- Who participates in the system development life cycle?

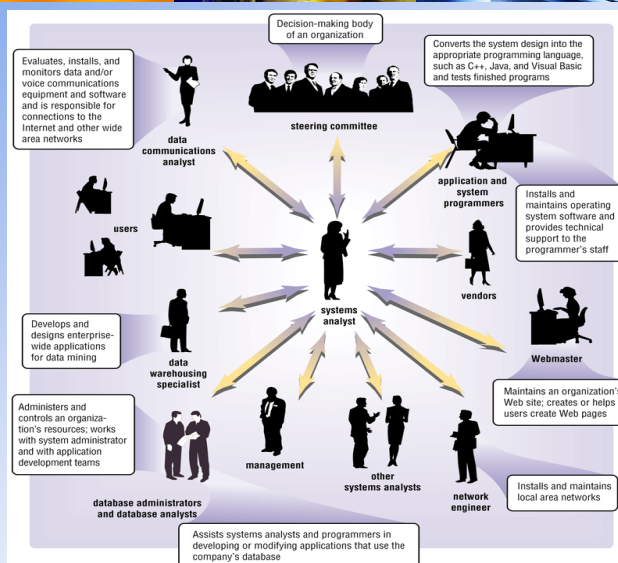

## What is the System Development Cycle?

- What is a **systems analyst**?

Responsible for designing and developing information system

Liaison between users and IT professionals

Next

## What is the System Development Cycle?

- What is the **project team**?

Formed to work on project from beginning to end

Consists of users, systems analyst, and other IT professionals

**Project leader**—one member of the team who manages and controls project budget and schedule

p. 623

Next

## What is the System Development Cycle?

- What is **project management**?
  - Process of planning, scheduling, and controlling activities during system development cycle
  - **Project leader** identifies elements for project

Goal, objectives, and expectations, collectively called scope

Required activities

Time estimates for each activity

Cost estimates for each activity

Order of activities

Activities that can take place at same time

p. 623

Next ▶

## What is the System Development Cycle?

- What is a Gantt chart?
  - Popular tool used to plan and schedule large, complex projects

| ID | Task Name      | Duration | Jan  | Feb | Mar  | Apr | May  | Jun  | Jul | Aug |
|----|----------------|----------|------|-----|------|-----|------|------|-----|-----|
| 1  | Planning       | 2w       | 1/20 | 2/1 |      |     |      |      |     |     |
| 2  | Analysis       | 12w      |      | 2/8 |      |     | 5/10 |      |     |     |
| 3  | Design         | 12w      |      |     | 3/20 |     |      | 6/15 |     |     |
| 4  | Implementation | 7w       |      |     |      |     |      | 6/16 |     | 8/9 |

p. 623 - 624 Fig. 12-3

Next ▶

## What is the System Development Cycle?

- What is **project management software**?
  - Program used by project leaders to plan, schedule, and control development projects

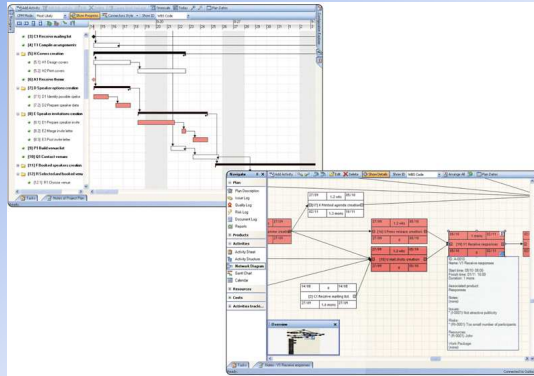

p. 624 Fig. 12-4

Next

## What is the System Development Cycle?

- What is **feasibility**?

Measure of how suitable system development will be to the company

Four feasibility tests:

Operational feasibility

Schedule feasibility

Economic feasibility (also called cost/benefit feasibility)

Technical feasibility

p. 625

Next

## What is the System Development Cycle?

- What is **documentation**?

Collection and summarization  
of data and information

Includes reports, diagrams,  
programs, and other deliverables

Project notebook contains all  
documentation for single project

p. 625

Next

## What is the System Development Cycle?

- What are six data and information gathering techniques?

- **Review documentation**
- **Observe**
- **Questionnaire**
- **Interview**
- **Joint-application design (JAD) session**
- **Research**



p. 625 - 626 Fig. 12-5

Next

## What Initiates the System Development Cycle?

- What are some reasons to create or modify an information system?

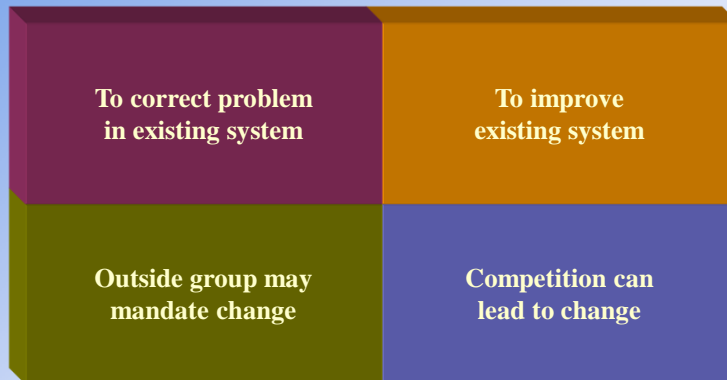

p. 626

Next

## Planning Phase

- What is the **planning phase**?

Begins when steering committee receives project request

Steering committee—  
decision-making  
body for the  
company

### Function of committee:

Review and  
approve project  
requests

Prioritize  
project requests

Allocate  
resources

Form project  
development  
team for each  
approved  
project

p. 629

Next



# Analysis Phase

## What is the analysis phase?

Conduct preliminary investigation, also called feasibility study

Perform detailed analysis

p. 630



# Analysis Phase

## What is the preliminary investigation?

### Determine exact nature of problem or improvement and whether it is worth pursuing

- Findings are presented in feasibility report, also known as a feasibility study

**Cyber Coast Café**  
MEMORANDUM

**To:** Executive Committee  
**From:** Bart Stinson, Project Leader  
**Subject:** Feasibility Study of Mobile Web System

This memorandum provides information on the proposed mobile application for Cyber Coast Café. The purpose of this study is to determine whether the proposed mobile application is a viable and profitable investment for Cyber Coast Café. The findings of this study will be used to guide the decision on whether to proceed with the development and implementation of the mobile application.

**Background**

Cyber Coast Café is looking for a mobile application that will allow customers to place orders, view the menu, and make reservations. The proposed mobile application will be developed for both iOS and Android. The application will be developed using a cross-platform framework, such as React Native or Flutter. The application will be developed using a cloud-based backend, such as AWS or Azure. The application will be developed using a mobile-first design approach, which means that the application will be designed for mobile devices first and then adapted for desktop devices.

**Findings**

The following findings have been identified with the current information system at Cyber Coast Café:

- Customer spends much time waiting and applying vendor information
- Customer wants to not access internet as quickly as in the past, which possibly could cause lost sales
- Customer wants to make reservations in advance, which possibly could cause lost sales

**Feasibility Study**

**Page 1**

**Benefits of a New or Modified System**

- Mobile order interface will reduce waiting time for mobile app users
- Cost of system will be relatively low
- Through a more efficient use of employees' time, the company could achieve a 20 percent increase in revenue within the existing budget
- User interface and design will be user-friendly

**Feasibility of a New or Modified System**

**Operational**

The proposed system will increase the amount of customer use and support. Vendor information will be available to all users, increasing the number of users. Employees will have time to complete other tasks, allowing the staff to be more efficient.

**Technical**

Cyber Coast Café already has a functional web site. To handle the increased volume of data, it will need to purchase a database server.

**Resource**

A limited number of the staff and benefits, including all employees, is available on our IT system. The proposed system of the proposed system will require the staff to be trained. The cost of training is relatively low and will be covered by the company.

If you have any questions about the proposed system, please contact me for further information.

**Recommendation**

Based on the findings presented in this report, we recommend a qualified step of the proposed system.

p. 630 Fig. 12-8



## Analysis Phase

### What is detailed analysis?

1. Study how current system works

2. Determine user's wants, needs, and requirements

3. Recommend solution

Sometimes called logical design

p. 631

Next

## Analysis Phase

### What is process modeling?

Technique that describes processes that transform inputs into outputs  
Also called structured analysis and design

Three tools used for process modeling

Entity-relationship diagrams

Data flow diagrams

Project dictionary

p. 632 - 633

Next

## Analysis Phase

- What is an **entity-relationship diagram (ERD)**?
- Tool that graphically shows connections among entities in system

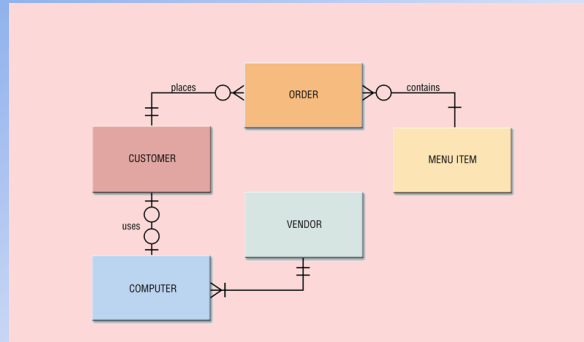

p. 632 Fig. 12-9

Next

## Analysis Phase

- What is a **data flow diagram (DFD)**?
- Tool that graphically shows flow of data in system

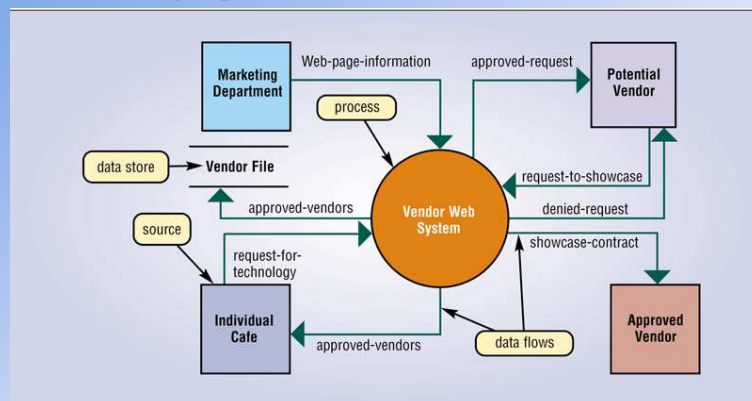

p. 632 - 633 Fig. 12-10

Next

## Analysis Phase

### What is a **project dictionary**?

Contains all the documentation and deliverables of project

Helps keep track of huge amount of details in system

Variety of techniques to enter items in project dictionary

Structured English

Decision tables

Decision trees

Data dictionary

p. 633 - 635

Next

## Analysis Phase

### What is **Structured English**?

- Used to explain details of process

#### **UPLOADING VENDOR INFORMATION**

For each item containing vendor information, perform the following steps:

If the item is not a computer file then

Use the scanner to convert it into a file format.

Copy the file into the Vendor Information folder on the hard disk.

Zip all new files in the Vendor Information folder into a single file.

Save the zipped file in a Web folder.

E-mail the Webmaster with the name of the zipped file.

p. 633 Fig. 12-11

Next

## Analysis Phase

- What is a **decision table**?
  - Lists variety of conditions and actions that correspond to each condition

|            |  | RULES |   |   |   |   |   |   |   |
|------------|--|-------|---|---|---|---|---|---|---|
|            |  | 1     | 2 | 3 | 4 | 5 | 6 | 7 | 8 |
| CONDITIONS | Background check results<br>(S = Satisfactory, U = Unsatisfactory) | S     | S | S | S | U | U | U | U |
|            | References furnished?  | Y     | Y | N | N | Y | Y | N | N |
|            | Passed credit check?   | Y     | N | Y | N | Y | N | Y | N |
| ACTIONS    | Vendor approved  | X     |   |   |   |   |   |   |   |
|            | Vendor not approved  |       | X |   |   | X | X | X | X |
|            | Waiting for additional information                                 |       |   | X | X |   |   |   |   |

p. 634 Fig. 12-12



## Analysis Phase

- What is a **decision tree**?
  - Shows conditions and actions graphically

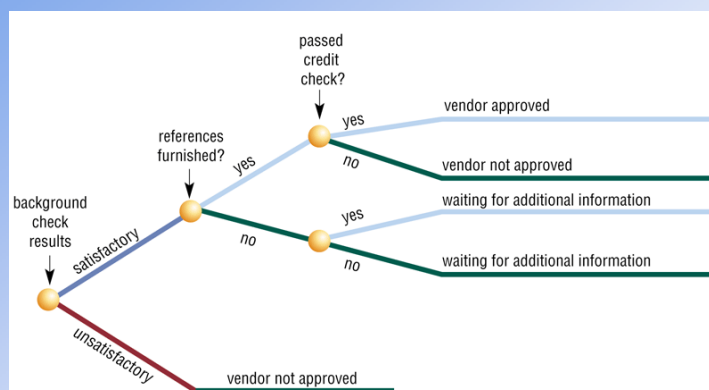

p. 634 Fig. 12-13



## Analysis Phase

- What is a **data dictionary**?

- Stores name, description, and other details about each data item

|   |                                    |              |
|---|------------------------------------|--------------|
| Date: 12/29/2008  | Project: CYBER COAST CAFE          | Page: 11     |
| Time: 10:36:28 AM                                       | Detailed Listing -- Alphabetically |              |
|   | All Entries -- Data Flow Diagrams  |              |
| <hr/>   |                                    |              |
| Vendor ID   |                                    | Data Element |
| <a href="#">Vendor File</a> - <a href="#">Vendor ID</a> |                                    |              |
| <i>Description:</i>                                     |                                    |              |
| A unique identification number assigned to each vendor. |                                    |              |
| <i>Alias:</i>   |                                    |              |
| <a href="#">Vendor Code</a>                             |                                    |              |
| <i>Values &amp; Meanings:</i>                           |                                    |              |
| Required element  |                                    |              |
| Cannot be blank   |                                    |              |
| May not be duplicated                                   |                                    |              |
| <i>Data element attributes</i>                          |                                    |              |
| <i>Storage Type:</i>                                    | Char                               |              |
| <i>Length:</i>  | 4                                  |              |
| <i>Display Format:</i>                                  | AAAA                               |              |
| <i>Null Type:</i>                                       | NotNull                            |              |
| <i>Location:</i>  |                                    |              |
| File -->  | <a href="#">Vendor File</a>        |              |
| <i>Date Last Altered:</i> 12/29                         | <i>Date Created:</i> 12/29         |              |

p. 635 Fig. 12-14

Next

## Analysis Phase

- What is **object modeling**?

Combines data with the processes that act on data into single unit called an **object**

**Object**—an item that can contain both data and procedures that read or manipulate the data

Sometimes called **object-oriented (OO)** analysis and design

Uses **Unified Modeling Language (UML)**—graphical tool for documenting system

Next

## Analysis Phase

- What is a **use case diagram**?
- Graphically shows how actors interact with information system

- **Actor**—user or other entity
- **Use case**—function that actor can perform

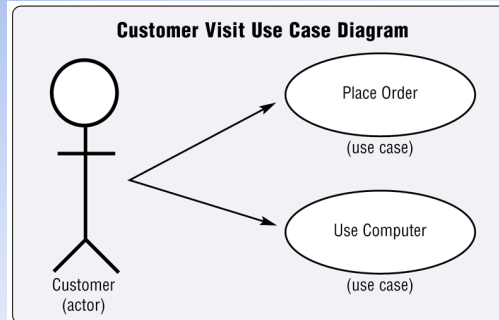

p. 636 Fig. 12-15

Next

## Analysis Phase

- What is a **class diagram**?
- Graphically shows classes and subclasses in system

- Class is group of objects—  
Can have lower levels called **subclasses**

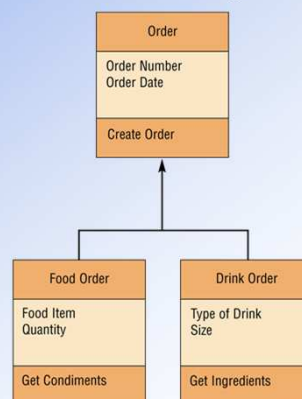

p. 636 Fig. 12-16

Next

## Analysis Phase

### What is the system proposal?

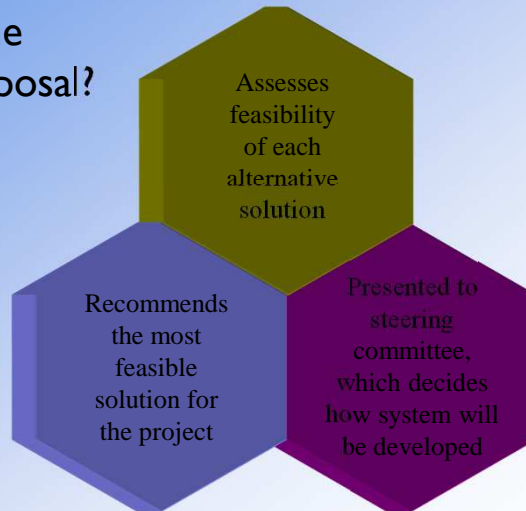

p. 636

Next

## Analysis Phase

### What are possible solutions?

Buy **packaged** software—prewritten software available for purchase

Write own **custom software**—software developed at user's request

Outsource—have outside source develop software

Horizontal market software—meets needs of many companies

Vertical market software—designed for particular industry

Next



## Analysis Phase

- What is an example of outsourcing?
  - Using Internet solutions provider
    - Internet solutions provider provides Web hosting services



p. 637 Fig. 12-17



## Design Phase

- What is the design phase?

Acquire hardware and software

Develop all details of new or modified information system

p. 639



## Design Phase

- What is needed to acquire new hardware and software?
  - **Identify all hardware and software requirements of new or modified system**

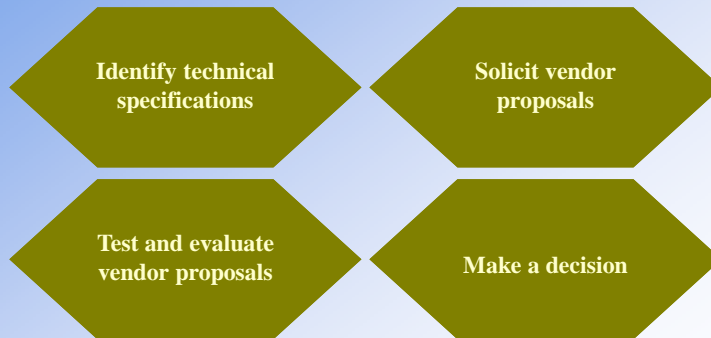

p. 639

Next ▶

## Design Phase

- What are three basic documents used to summarize technical specifications?



p. 639

Next ▶

## Design Phase

- How do systems analysts test software products?
  - References from vendor
  - Talk to current users of product
  - Product demonstrations
  - Trial version of software
  - Benchmark test measures performance

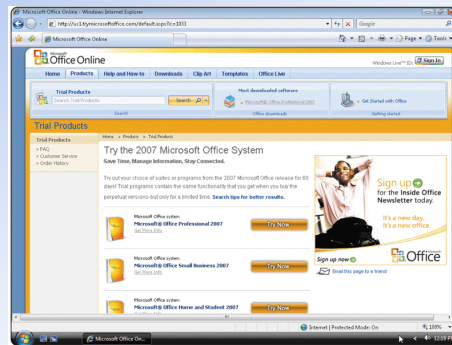

p. 640 Fig. 12-19

Next

## Design Phase

- What is a detailed design?

Detailed design specifications for components in proposed solution

Sometimes called  
physical design

Includes several activities

Database  
design

Input and  
output design

Program  
design

p. 641

Next

## Design Phase

- What is a mockup?
  - Sample of input or output that contains actual data

Vendor Maintenance Form

|               |                  |                   |                             |
|---------------|------------------|-------------------|-----------------------------|
| Vendor ID:    | TEER             | E-Mail Address:   | dh@earth.net                |
| Vendor Name:  | Tech Center      | Telephone Number: | 321-555-4555                |
| Address:      | 23 Second Street | Fax Number:       | 321-555-4556                |
| City:         | Chicago          | Product Line:     | printers, scanners, cameras |
| State:        | IL               | Notes:            | Closed Sunday               |
| Postal Code:  | 60606            |                   |                             |
| Contact Name: | Debbie Holstein  |                   |                             |

p. 641 Fig. 12-20

Next

## Design Phase

- What is a layout chart?
  - Input or output that contains programming-like notations for data items

Vendor Maintenance Form

|               |            |                   |              |
|---------------|------------|-------------------|--------------|
| Vendor ID:    | AAAA       | E-Mail Address:   | X(30)        |
| Vendor Name:  | X(25)      | Telephone Number: | 999-999-9999 |
| Address:      | X(25)      | Fax Number:       | 999-999-9999 |
| City:         | X(20)      | Product Line:     | X(50)        |
| State:        | XX         | Notes:            | X(100)       |
| Postal Code:  | 99999-9999 |                   |              |
| Contact Name: | X(30)      |                   |              |

p. 641 Fig. 12-21

Next

## Design Phase

- What is a **prototype**?

Working model of proposed system

Beginning a prototype too early may lead to problems

p. 642

Next

## Design Phase

- What is computer-aided software engineering (CASE)?
  - Software tools designed to support activities of system development cycle

Project repository—Stores diagrams, specifications, descriptions, programs, and other deliverables

Graphics—Enables drawing of diagrams

Prototyping—Creates models of proposed system

Quality assurance—Analyzes deliverables for accuracy

Code generators—Create actual computer programs from design specifications

Housekeeping—Establishes user accounts and provides backup and recovery functions

p. 642 - 643

Next

## Design Phase

- What is integrated computer-aided software engineering (I-CASE)?

- Integrated case products

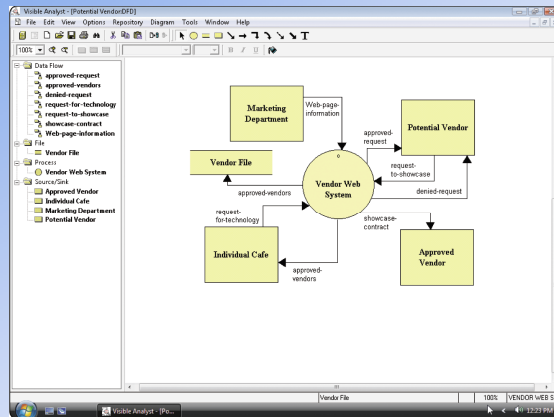

p. 642 - 643 Fig. 12-22

Next

## Design Phase

- What is an inspection?

|   |   |
|---|---|
| Step-by-step review by project team and users of any system development cycle deliverable | Used to review detailed design specifications before they are given to programming team |
| Identifies any errors and allows IT personnel to correct them                             | Used throughout entire system development cycle to review a variety of deliverables     |

p. 643

Next

## Implementation Phase

- What is the **implementation phase**?
  - Purpose is to construct, or build, new or modified system and then deliver it to users



p. 643

Next

## Implementation Phase

- What is the **program development cycle**?
  - Programmers write programs from specifications
  - Follows six steps

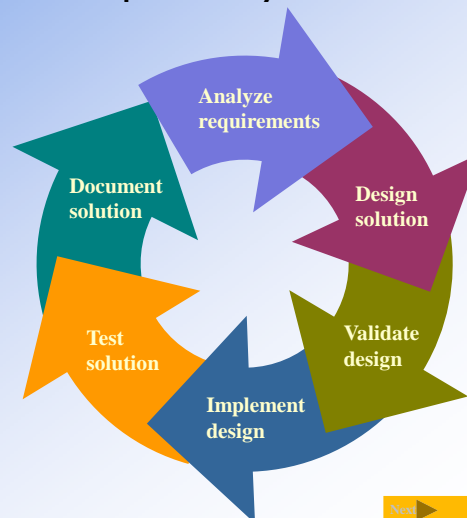

p. 643

Next



## Implementation Phase

■ What are the four types of tests performed by system developers?

|  |  |
|--|--|
| <p><b>Unit Test</b></p> <p>Verifies each individual program works by itself</p>          | <p><b>Systems test</b></p> <p>Verifies all programs in application work together</p> |
| <p><b>Integration Test</b></p> <p>Verifies application works with other applications</p> | <p><b>Acceptance Test</b></p> <p>Verifies the new system works with actual data</p>  |

p. 644 Next ▶

## Implementation Phase

■ What is **training**?

- Showing users exactly how they will use new hardware and software in system



p. 644 Fig. 12-23 Next ▶



## Implementation Phase

- What are conversion strategies?
  - Used to change from old system to new system

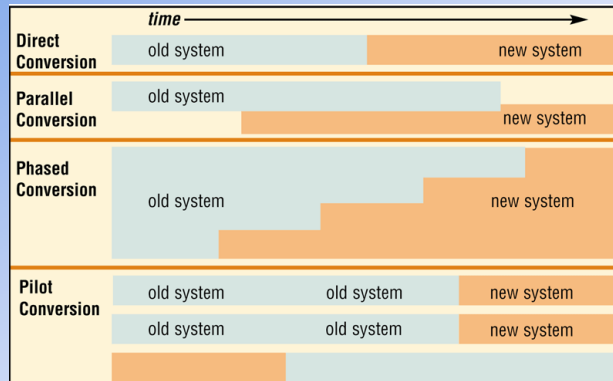

p. 644 - 645 Fig. 12-24

Next

## Operation, Support, and Security Phase

- What is the **operation, support, and security phase**?
- Provides ongoing assistance after system is implemented

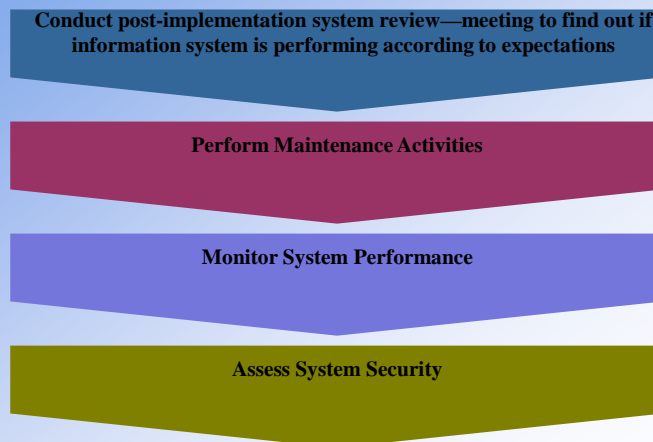

p. 646

Next

## Operation, Support, and Security Phase

- What is a **computer security plan**?
  - Summarizes in writing all of the safeguards that are in place to protect a company's information assets

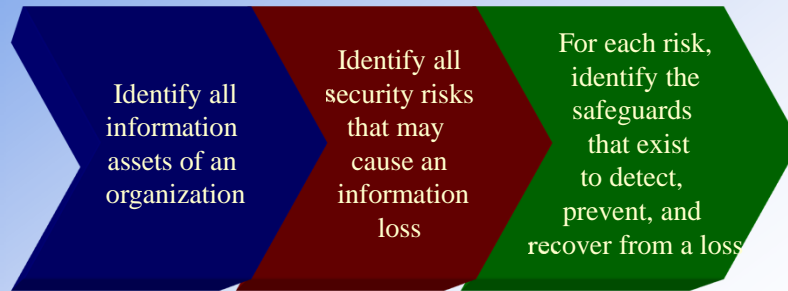

p. 646

Next ▶

# SELESAI